

GPCA-1

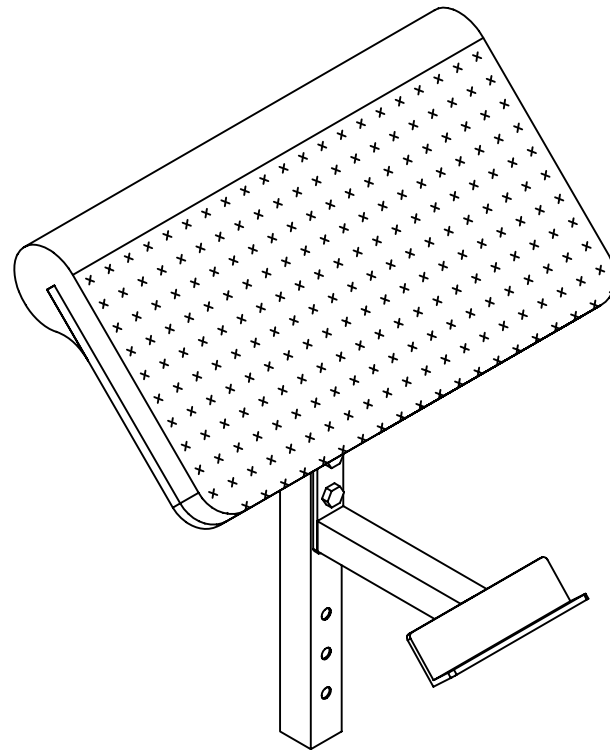

VERSION 0506

GPCA-1

HARDWARE ILLUSTRATION SHEET

PARTS ILLUSTRATION SHEET

	Qty.
A1. M12X70 HEX HEAD BOLT -----	[2PCS]
A2. 5/16"X1" HEX HEAD BOLT -----	[2PCS]
B1. M12 NYLON LOCK NUT -----	[2PCS]
C1. M12 (I.D)WASHER -----	[2PCS]
C2. 5/16" WASHER -----	[2PCS]
C3. 5/16" SPRING WASHER -----	[2PCS]

A1



A2



B1



C1



C2



C3



A [1PCS]

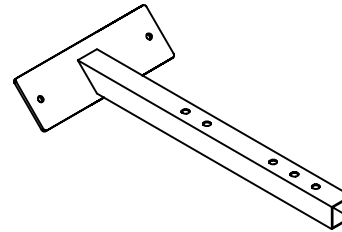

B [1PCS]

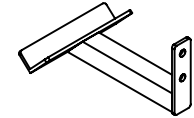

C [1PCS]

